

Contents

P/N: 390712000127 Version: B

1. Technical feature	02
2. Photometric diagram	03
3. Control channel	04
4. Display panel operational function detail	07
5. Control panel	08
5.1 Control panel introduction	08
5.2 Control panel operational introduction	08
6. Routine maintenance	09
7. Safety information	10
8. Product connection	11
8.1 Included items	11
8.2 Power connection	11
8.3 Signal connection	11
9. Parts Code	14
Attached 1. Fixture exploded drawing	
Attached 2. Wiring diagram	

1 .Technical feature

Technical Feature	FINE 75 FT
Light Source	3W LED light source
Input Voltage	100-240V~ 50/60Hz
Input Current	1A
Input Power	Max 100W
Power Factor	PF \geq 0. 95
Initial Luminous Flux	2202 lm
Initial Efficiency	21.59 lm/W
Safety Protection	Over current, over voltage and overheating
Control Mode	DMX512/Wireless DMX (optional)
Working Temperature	0°C~40°C
Fixture Dimension	492x139x102mm
Package Dimension	1224x839x374mm
Weight	Net Weight: 4.7 kg, Gross Weight: 95kg
Package	10pcs/flight case
IP Rate	IP20

Note: The light source is a non-user replacement light source.
If it is damaged or thermally deformed, please replace it!

2. Photometric diagram

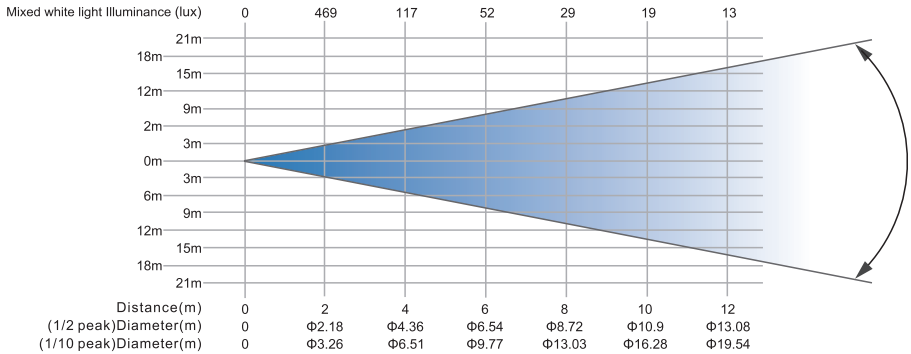

PAN (1/2 peak 57°)
(1/10 peak 70°)

TILT (1/2 peak 67°)
(1/10 peak 90°)

3. Control channel

Stand:

ID	Specific	Value	Function
1	Top Dimmer	0->255	
2	Top DimmF	0->255	
3	Top Red	0->255	
4	Top Green	0->255	
5	Top Blue	0->255	
6	Top White	0->255	
7	BotDimmer	0->255	
8	BotDimmF	0->255	
9	BotRed	0->255	
10	BotGreen	0->255	
11	BotBlue	0->255	
12	BotWhite	0->255	
13	CCT	0->3 None 4 CCT 2500K 5 CCT 3200K 6 CCT 4500K 7 CCT 5600K 8 CCT 6500K 9 CCT 8000K 10->255 CCT 10000K -> 2500K	
14	ColorMacro	0->27 None 28->127 ColorMacro 128->255 None	
15	Strobe	0->5 Close 6->10 Open (Dimmer Fade OFF) 11->105 Pulse Strobe, from slow to fast (0~20Hz) 106->110 Open(Dimmer Fade ON) 111->179 Thunder Strobe(0~10Hz) 180->185 Open(Dimmer Fade ON) 186->253 Random Strobe, from slow to fast 254->255 Open(Dimmer Fade ON)	
16	Ctrl	0->255 Reserved	

SIMP:

ID	Specific	Value	Function
1	Dimmer	0->255	
2	DimmerFine	0->255	
3	Red	0->255	
4	Green	0->255	
5	Blue	0->255	
6	White	0->255	
7	CCT	0->3 None 4 CCT 2500K 5 CCT 3200K 6 CCT 4500K 7 CCT 5600K 8 CCT 6500K 9 CCT 8000K 10->255 CCT 10000K -> 2500K	
8	ColorMacro	0->27 None 28->127 ColorMacro 128->255 None	
9	Strobe	0->5 Close 6->10 Open (Dimmer Fade OFF) 11->105 Pulse Strobe,from slow to fast (0~20Hz) 106->110 Open(Dimmer Fade ON) 111->179 Thunder Strobe(0~10Hz) 180->185 Open(Dimmer Fade ON) 186->253 Random Strobe,from slow to fast 254->255 Open(Dimmer Fade ON)	
10	Ctrl	0->255 Reserved	

Pixels:

ID	Specific	Value	Function
1	Dimmer	0->255	
2	DimmerFine	0->255	
3	Bar1 Red	0->255	
4	Bar1 Green	0->255	
5	Bar1 Blue	0->255	
6	Bar1 White	0->255	
7	Bar2 Red	0->255	
8	Bar2 Green	0->255	
9	Bar2 Blue	0->255	
10	Bar2 White	0->255	
11	Strobe	0->5 Close 6->10 Open (Dimmer Fade OFF) 11->105 Pulse Strobe, from slow to fast (0~20Hz) 106->110 Open (Dimmer Fade ON) 111->179 Thunder Strobe (0~10Hz) 180->185 Open(Dimmer Fade ON) 186->253 Random Strobe, from slow to fast 254->255 Open (Dimmer Fade ON)	
12	Ctrl	0->255 Reserved	

4 .Display panel operational function detail

FirstLevel	SecondLevel	ThirdLevel	Option/Value	Default	Description
Address	DMX Addr		1->512	1	DMX Address
Option	Ch Mode		Stand 16/SIMP 10/ Pixels 12	Stand 16	Channel Mode
	PowerMode		Power/Stand/Theater	Stand	It is maximum power and noise when the value is Power; It is 85% power and lower noise when the value is Stand; It is 70% power and lowest noise when the value is Theater;
	DimmCurve		Default/Power2/Power3	Default	
	DimmFreq		1.2K/6K/12K/24K	1.2K	Dimmer frequency
	Language		CHS/ENG	CHS	Language
Auxiliary	BKLgtTime		30Sec/60Sec/ON	30Sec	Display Screen Background Lighting time
	Brightness		0-255	255	reserve
	BKWarn		ON/OFF	ON	Display Screen Background Lighting warning
	DispRev		Action	Action	Display Screen Reverse
	Config1		Load/Save	Load	User Config1 Load/Save
	Config2		Load/Save	Load	User Config2 Load/Save
	Manual	ChannCtrl		Channel Function Manual Ctrl	
Reset					Reset
Info	Fixture		F75FT		Device short name
	DispB Ver		V0.XX		Disp Board Version
	DispB Temp		40℃		Disp Board Temperature
	ManuID		05EF		Manufactory ID
	DeviceID		05EFxxxxxx		Device ID
	ErrorInfo				Error Information
	DMX VAL				DMX Value

5 .Control Panel

5.1 Control panel introduction

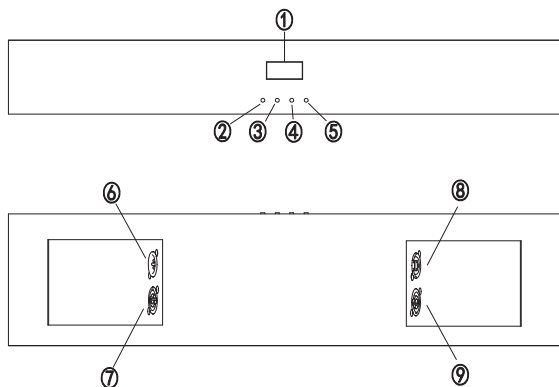

1. Display
2. Menu button
3. Confirm button
4. UP Key
5. Down Key
6. Signal input
7. Power input
8. Signal output
9. Power output

Fig.(5.1-1)

5.2 Control panel operational introduction

Main Menu interface

Main Menu	
Addresss Settings	001-XXX
Feature Settings	
Speed Settings	
Channel Settings	
▼	

Note: Enter the main menu interface (the gray area indicates the selected menu), if you are sure to enter this menu, press the menu key, the up/down key can turn the page, and the confirm key can select the required function settings.

6. Routine maintenance

This fixture requires routine cleaning. The service life depends on the operating environment heavily. Please kindly contact GUANGZHOU CHAIYI LIGHT CO., LTD for more maintenance information not included in this user's manual.

Notice: Excessive dust, smoke fluid and particulate buildup will degrade performance and cause over heating or damage to the fixture that is not covered by the warranty.

Warning: Please unplug the fixture before you open any covers.

Cleaning

Optical components should be cleaned carefully and lightly. Coating face is easily damaged, do not use harmful solvent so as to avoid damage to plastic parts or coating parts.

Cleaning optical components

1. Switch off the fixture and keep it cool completely, then open the cover.
2. Clean the floats by dust collector or compressed.
3. Use cotton paper without smell or cotton cloth soaked with the water, distilled water to wipe the granular thing, don't wipe the surface, float things should be blown away by the pressure gas.
4. Use the cotton cloth or cotton paper without smell soaked with isopropyl alcohol to remove the smoke and other residues. A commercial glass cleaner may be used, but residues must be removed with distilled water. Clean with a slow circular motion from center to edge. Dry with a clean, soft and lint-free cloth or compressed air.

Cleaning fan and air vents

Remove dust from the fans and air vents with a soft brush, cotton paper, vacuum, or compressed air.

7. Safety information

The following symbols are used to identify important safety information on the product and in this manual.



DANGER!
Safety hazard.
Risk of severe injury or death.



DANGER!
Refer to manual before installing, powering or servicing.



DANGER!
Hazardous voltage. Risk of severe or lethal electric shock.



Warning!
Fire hazard.



Warning!
Burn hazard. Hot surface. Do not touch.



Warning!
Risk of eye injury. Safety glasses must be worn.



Warning!
Do not stare at the bulb which is still on.



Warning!
Risk of hand injury. Safety gloves must be worn.



Replace any cracked protective shield.



Minimum distance from lighted objects is 0.5m.



For indoor use only.



Do not direct lens to sun ray or strong light!



Do not actuate during operating.



Luminaires not suitable for direct mounting on normally flammable surfaces (suitable only for mounting on non-combustible surfaces)

$t_c \dots \text{°C}$

$t_a \dots \text{°C}$

The surface's temperature is 70°C.

Rated maximum ambient temperature is 40°C.

Protection against explosion



Protection screen must be replaced if they have become visible damaged to such an extent that their effectiveness is impaired.



Do not actuate during operation.

Do not operate the luminaire with a missing or damaged shield.
Do not touch the lamp at any time. Use a soft cloth. Oil from skin may damage lamp.

8. Product Connection

8.1 Included items

FINE 75 FT is packed with flight case. One single standard flight case carries ten fixtures, Included items listed below (shown as table 8.1-1):

Accessories	QTY	UNIT
User manual	1	PCS
Warranty card	1	PCS
Suspension fasteners	2	SET
Signal cable	1	PCS
Safety wire	1	PCS

Table(8.1-1)

8.2 Power connection

Notice: Type Y attachment for power supply connection. Method of attachment of the cable or cord such that any replacement can only be made by the manufacturer, his service agent or similarly qualified person.

The person must have the relevant qualification to connect the power supply. The AC power voltage shall be suitable to the lamp provided with over-loading or creepage protection.

Connecting the equipment to the power supply, do not connect to silicon box system, or else, it will destroy the equipment.

1. The fixture is provided with standard 3-pin socket. Please according to table (8.2-1) connect to power supply, Yellow/green line must be earthed.

Color	Wire	Mark
Brown	Live	L
Blue	Neutral	N
Yellow/Green	Earth	

Table(8.2-1)

2. At a voltage of 220V, up to 26 lamps can be connected in series, when at a voltage of 110V, up to 13 lamps can be connected in series. If you still have any question to the installation, please consultant with the experienced electrician.

8. 3 Signal connection

Data linkage for the fixture may be provided by DMX512 connection and wireless linkage.

■ DMX connection

Note: The signal cable was type X connection.

TypeX connection—if the external flexible cable or cord of this fixture is damaged, it shall be replaced by a special cord or cord exclusively available from the manufacturer or his service agent.

3-pin or 5pin XLR connectors are provided for fixture DMX input and output. Pin 1 is for earthing, pin 2 is for minus signals, and pin 3 is for plus signals.

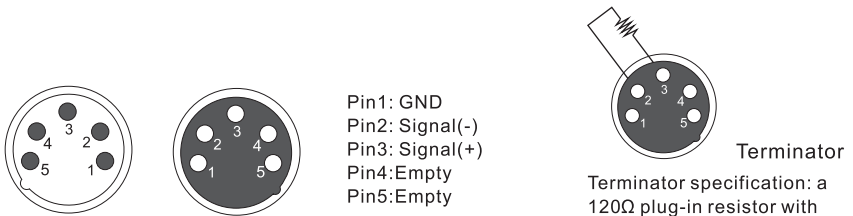

5-pin XLR connector

Fig.(8.3-1)

Terminator specification: a 120Ω plug-in resistor with rated power of 0.25W, soldered between pin 2 and pin 3 at the end of respective data link.

Connect the fixtures with Max.32 pieces. Make sure to insert the “signal in” terminal in the last connecting fixture. shown in Fig.(8.3-2).

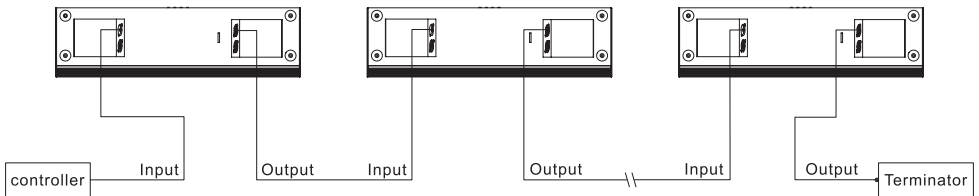

Fig.(8.3-2)

If long-distance data transfer occurs, a DMX512 signal amplifier is necessary. The added amplifier is inserted between the lighting controller and the first fixture on the basis of a normal data link.



Notice!

1. No more than one signal input or output can occur in one fixture.
2. Don't split a data link via output ports on the fixture, use a DMX512 signal amplifier instead, if necessary.
3. Use only shielded-pair cables, and standard microphone cable is not reliable for long-distance data transfer.

■ Wireless transmission (optional)

1. Customer might choose wireless edition fixture which supports wireless data transmission. Wireless signal control is pretty reliable within a 225m radius empty space, thus no need for physical connection for data transmission. All has to be done is to set up corresponding addresses.
2. 2.4GHz worldwide free frequency band available in wireless control. Such huge frequency band favors users with variable band options.
 - (a) Wireless receiving mode setup:
“Personality”→“Receive Mode”→“WDMX”
 - (b) Press emitter button to search preset address within a fixture. When it's done, remotely control a fixture through a controller, Shown as Fig.(8.3-3).

Notice:

1. Emitter location: Distribute the antenna higher than any barrier on floor as possible.
2. Antenna direction: Emitting antenna points to receiving antenna.
3. Antenna position: Keep away from EMI source as possible, such as WLAN antenna.

Controlled
Fixture

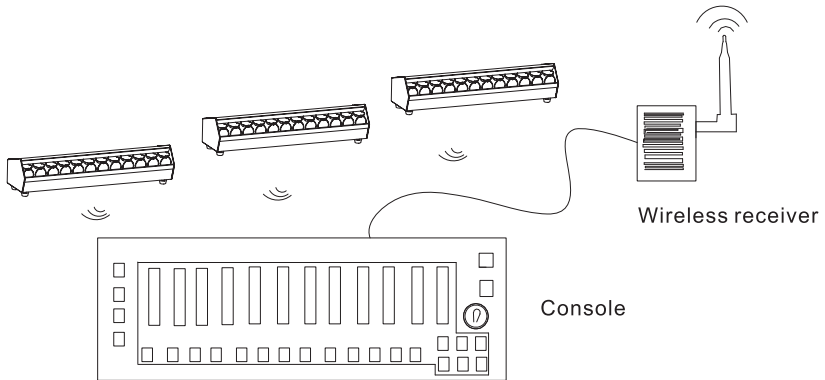
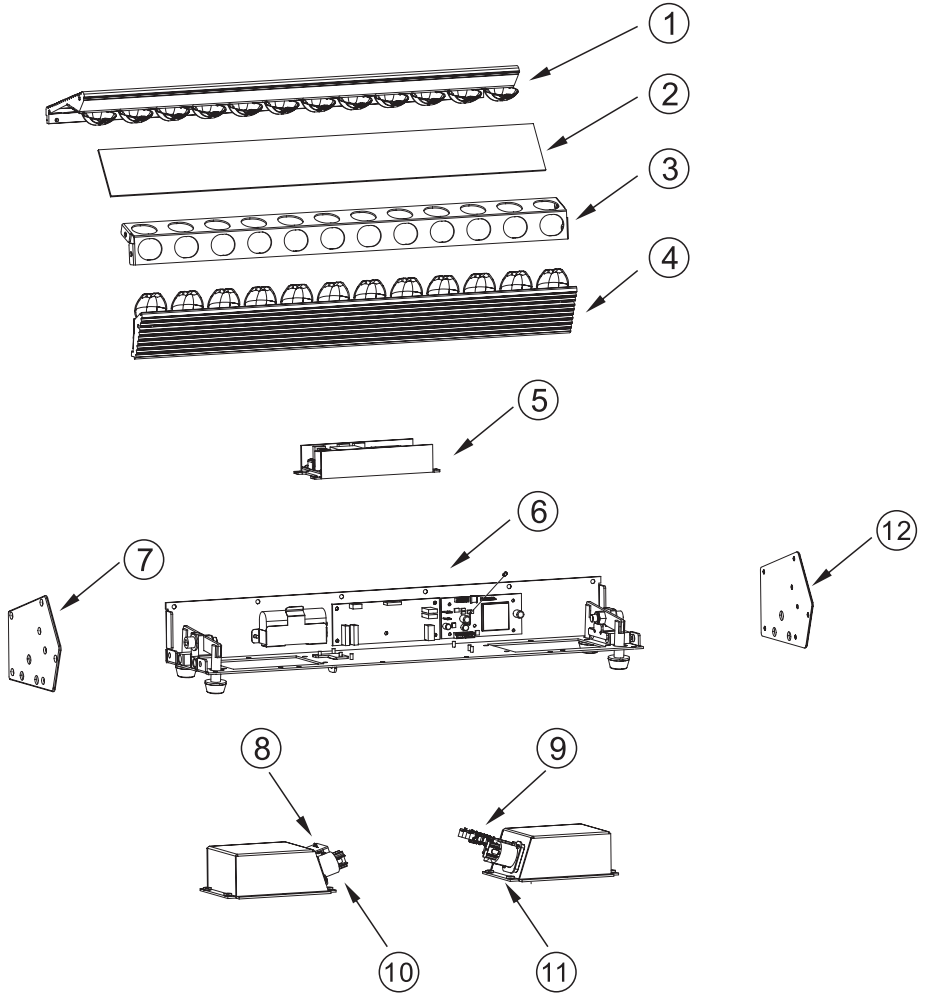

Fig.(8.3-3)

9/ Parts Code

Number	Item	Specification	Ordering index
1	LED light board	—	330712100202
2	Drive board	—	330712100199
3	Acrylic board	—	350712000099
4	Reflector cup	—	200710000038
5	Switch power	—	330001200044
6	Display board	—	330712100200
7	Female socket (blue)	—	300502000019
8	Female socket (white)	—	300502000020
9	DMX(male plug)	—	330712100197
10	DMX(male plug)	—	330712100198

Attached 1: Fixture exploded drawing



- 1. LED drive board module
- 2. Transparent acrylic board
- 3. Baffled plate
- 4. LED board module

- 5. Mains switch
- 6. Display board
- 7. Side plate 1
- 8. DMX out

- 9. DMX in
- 10. Power out
- 11. Power in
- 12. Side plate 2